



# Your guide to working on the road and staying alive!

Published by the New Zealand Utilities Advisory Group

These guidelines are based on the National Code of Practice for Utility Operators' Access to Transport Corridors and the Guide for Safety with Underground Services.



## Contents

Introduction .....	1
Are your priorities right?.....	2
Definitions - things you need to know .....	3
Personal Protective Equipment (PPE) .....	4
Before you start work on-site, prepare! .....	7
Typical road with utility layout and hazards .....	8
Utility location realities .....	10
Expect the unexpected! .....	12
Locating utility services .....	14
Follow safe digging practices .....	16
Standovers .....	17
Working near powerlines and cables etc .....	18
Traffic management .....	20
Trees .....	22
Protection of existing assets .....	24
Emergency procedures - electricity .....	26
Emergency procedures - gas .....	28
Maintaining stormwater networks .....	30
Surface markings and duct colours .....	31
Trenching procedures .....	32
Trench cutting and excavation .....	33
Backfill materials .....	35
General principles of surface layer reinstatement .....	36
Emergency phone numbers .....	41

## Introduction

This booklet is for anyone working on or around utility services in the road corridors. It is to help you:

- think safe, work safe, and go home safe
- do it right, do it once
- protect yourself, others and the environment.

Whether you are digging/trenching/using trenchless methods/boring the ground or working above ground or near overhead lines, you need to take steps to ensure you protect:

- yourself and your workmates
- people living nearby and people passing by
- traffic, including cyclists
- the environment (such as preventing dirty materials going into drains)
- utility services, whether they are electricity, gas, telephone, internet connections, water supply, sewer or stormwater services
- public property such as roads and footpaths, trees and plants, streetlighting, signage and bus shelters.

These guidelines help you to stay safe and do it right. They do not override any legislative or health and safety requirements. Make sure you know what the law requires.

The **ORANGE** section is designed specifically for workers.

The **PURPLE** section gives some technical advice for supervisors.

## Are your priorities right?

Get it right. We want to work where everyone thinks safe, works safe and gets to go home safe at the end of the day.

Get it wrong? You or your mates could be injured or even killed.

### SAFETY

The safety of you and the others around you is top priority

Nothing beats your right to be safe at work.

If you're not comfortable, talk to your employer, who must have systems in place to ensure the safety of all workers.

Safety is your responsibility too.

### QUALITY

Getting the job done right first time, not just done. This includes not damaging or interfering with any utilities in or above the ground.

The works may be under **Warranty** for up to **2 years** - your Company may have to carry the cost of any repairs or maintenance required within that period. So do it once - and do it right!

### Doing the job right first time is better for everybody. It means:

- you show everybody that you know what you're doing
- you don't have to come back and re-do the job
- you don't cut customers off or prevent **Emergency 111 Calls**
- you don't keep disrupting the traffic
- it is always cheaper in the long run
- you go home safe at the end of the day.

## Definitions - things you need to know

**Corridor Manager** is the organisation that manages the road or rail corridor, for example your local council or NZTA or KiwiRail. They process the **CAR** and the **WAP** and may also turn up to inspect works in progress or on completion of the job.

**CAR** is the **Corridor Access Request**. This is the application by a Utility Operator or their contractor to carry out works in the road/rail corridor.

**The Code** is the **National Code of Practice for Utility Operators' Access to Transport Corridors**.

**ECP34** is the **New Zealand Electrical Code of Practice** for electrical and safe distances.

**STMS** is the **Site Traffic Management Supervisor** who has responsibility for overall traffic management at the work site.

**WAP** is a **Works Access Permit**. This permit allows you to work on site. You must have one before any work can start on the site, and you must have a copy on site at all times.

**WCN** is the **Works Completion Notice**, it is issued when all the work is finished. It includes accurate information on the location and extent of the work, the quality assurance records and a signed statement that works comply with the conditions on the **WAP**.

**Utility Operator** is the operator or owner of the electricity, gas, postal, telecommunications, water supply, sewer and stormwater services in the road.

## Personal Protective Equipment (PPE)

You and your employer are responsible for your safety under the Health and Safety in Employment Act 1992. You must observe the Health and Safety instructions given to you by your employer. This includes wearing the right clothing for the job and using the right equipment.

This is referred to as **PPE - Personal Protective Equipment**.

### Do you need?

- hi-visibility clothing
- safety boots
- to remove jewellery, chains etc., as these may catch in equipment
- a hard hat to protect your head
- drinking water to keep you hydrated
- sunscreen to use whenever your skin is exposed to the sun
- sun protection such as sunhat or a shade ring for your hard hat
- sunglasses to protect you from sun glare
- long sleeves and long trousers (NZTA requires these)
- gloves to protect your hands
- safety glasses to stop things flying into your eyes
- hearing protection such as ear muffs or ear plugs
- fall protectors
- deep water protection
- portable confined space monitors.

### If you are working on gas or electricity services do you need?

- to avoid metal zips and buttons etc. on your clothes
- flame-retardant clothing
- anti-static clothing.

### Is there a risk of contamination at the site?

- this includes asbestos, sewerage, chemicals, old dumps, tank farms etc.
- do you need latex gloves, breathing protection, hand sanitiser and washing water with you?
- check with local and regional councils for their records.

If you feel unsafe, seek advice.

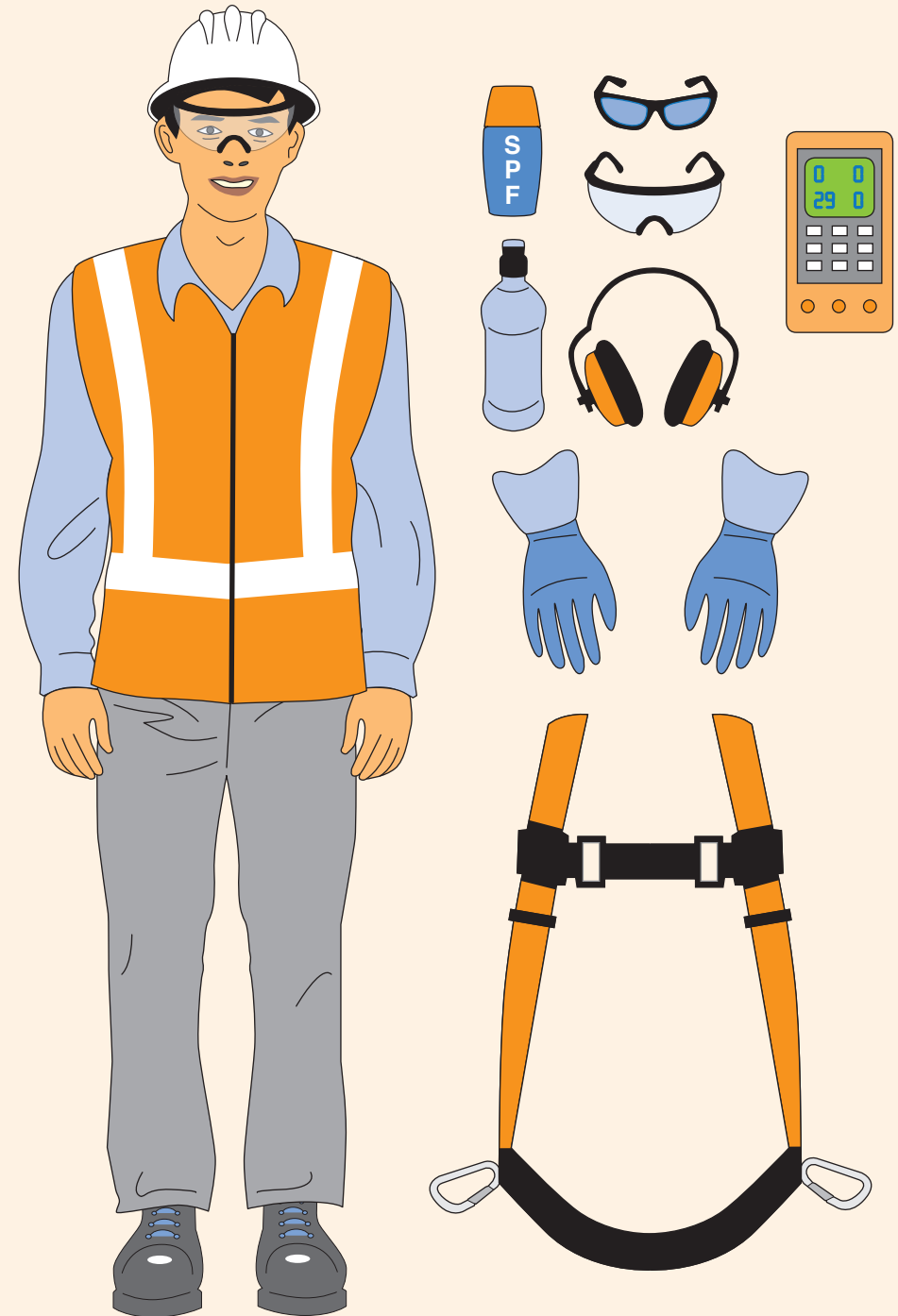

## Before you leave the depot for the work site, check that your employer has supplied:

- the right gear, **PPE**, tools, site protection equipment, phone/two-way radio, camera/video
- the project plan – and you understand what you are going to do today
- a Work Access Permit (**WAP**) with the conditions attached, unless the work is an emergency repair
- current plans of existing buried services from the owner of every utility buried in the ground where you will be working
- you can access plans, request a locate service and submit a **CAR** using a range of internet based services
- approved traffic management plan (**TMP**), pedestrian management and temporary access equipment such as ramps, steel covers etc.

## Depending on the work site, you may also need

- a **close approach** consent or agreements for overhead hazards
- an emergency plan
- archaeological plans
- a contamination management plan
- location of drinking water sources.



- SAFETY PLAN ✓
- TOOLS ✓
- PPE ✓
- SERVICE PLAN ✓
- CONSTRUCTION
- DRAWINGS ✓
- SITE PROTECTION ✓
- EQUIPMENT ✓
- CAMERA ✓
- PHONE ✓

## Before you start work on-site, prepare!

- check the **WAP** and any other consents for the conditions
- ensure the local residents have been informed of the work
- have all the right gear for the jobs in hand
- meet all the reasonable conditions contained on the **WAP**
- know who is responsible for documentation, such as for the works completion notice (**WCN**)
- check the site for any overnight vandalism to safety gear, pits etc
- take a photo of the work site and assess any existing damage on that work site
- photograph and record all road markings including types, location and any special markings
- check and re-check for any hazards or risks
- ensure the works site is clearly defined with barricades where appropriate, including any storage areas
- set/reset the traffic management equipment in accordance with the approved **TMP**
- check the service plans for all utilities
- ensure you have all on-site mark outs
- do you need cable and pipe locators?
- understand the construction drawings
- hold a safety briefing /toolbox meeting
- is a standover required?
- make sure any specialists or sub-contractors know their tasks eg compaction testing
- plan, plan and plan again!
- expect the unexpected.

# Typical road with utility layout and hazards

Ducts are often grouped together. Although some plans may show only one line, there actually could be more.



Services running up poles are a good indication that underground services are nearby.

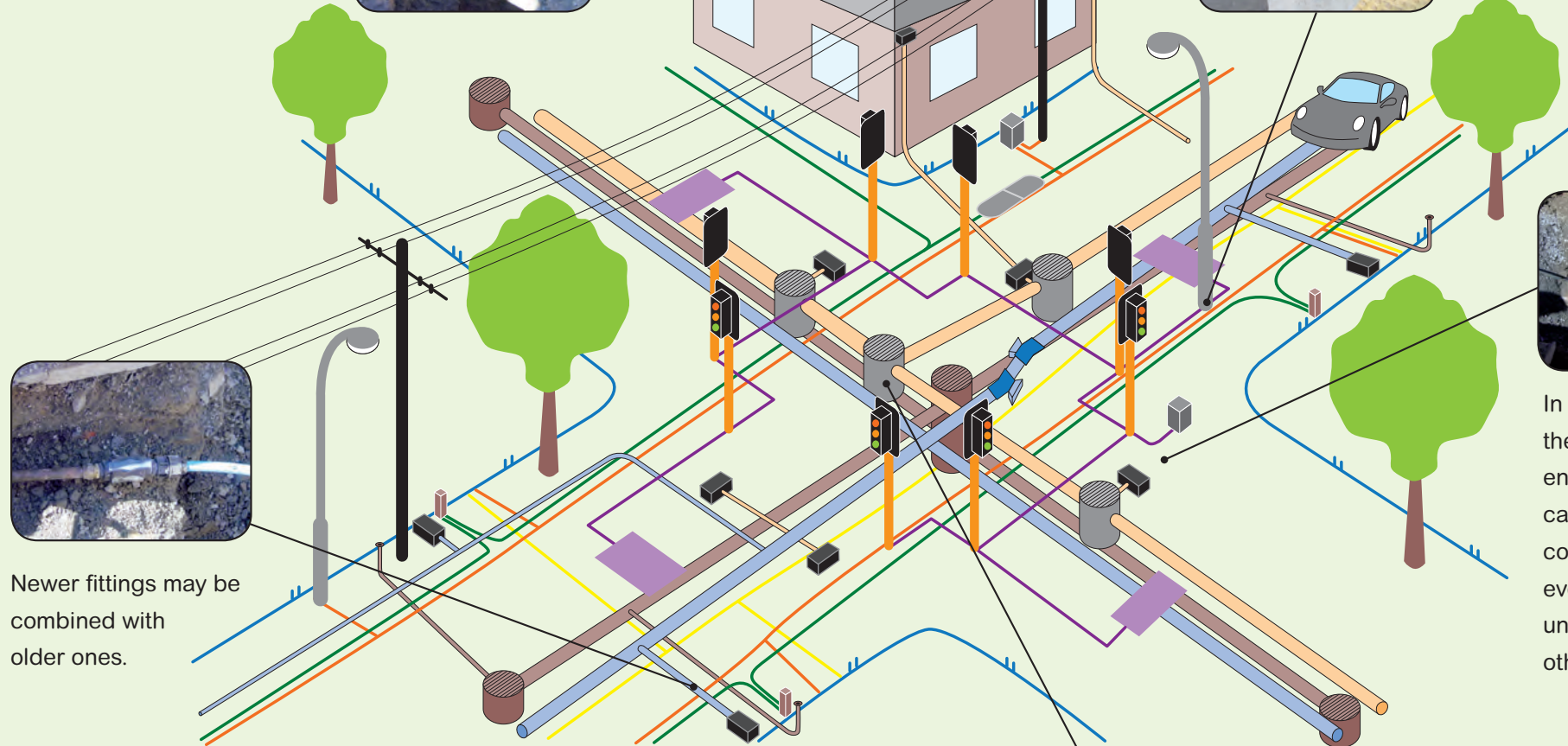

Newer fittings may be combined with older ones.



In some areas, the underground environment can be extremely congested. Assume everything is live unless confirmed otherwise.

**Ducts and small pipes (a general guide)**

Electricity	Stormwater	Overhead Lines
Telecomms	Traffic Lights	Boundaries
Fresh Water	Gas	Sewerage



Be careful not to damage smaller services when working around larger installations.

## Utility location realities

- plans may not be accurate
- roads are also lowered over time, so a pipe or duct that was **originally** 600mm deep may **now be** only 200mm deep, and vice-versa.
- services are often located by third parties
- if a service is shown, expect to find it! If it is not within the tolerances specified, i.e. you can't find it, call the service authority to have them confirm its location.

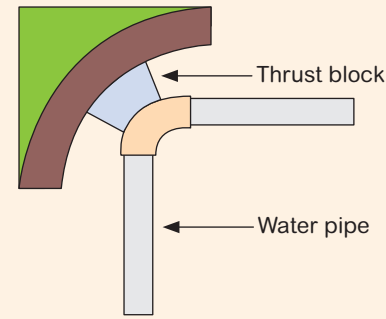
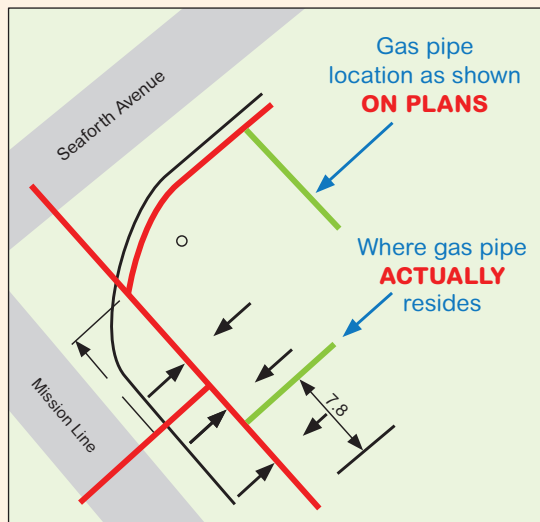
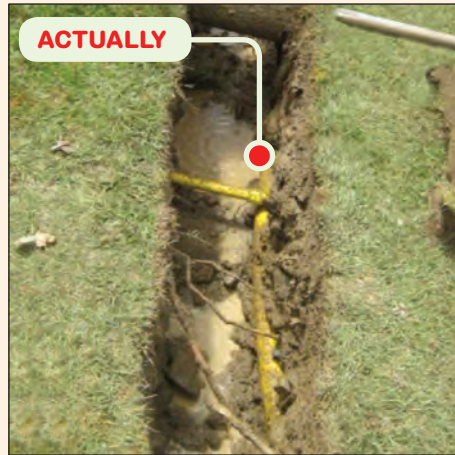
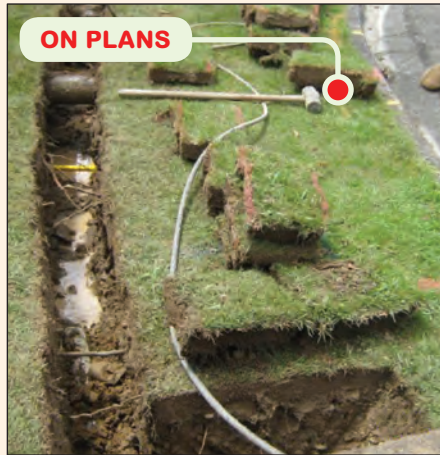

Do not remove the support in behind a thrust block. It's there to prevent the pipe from moving.

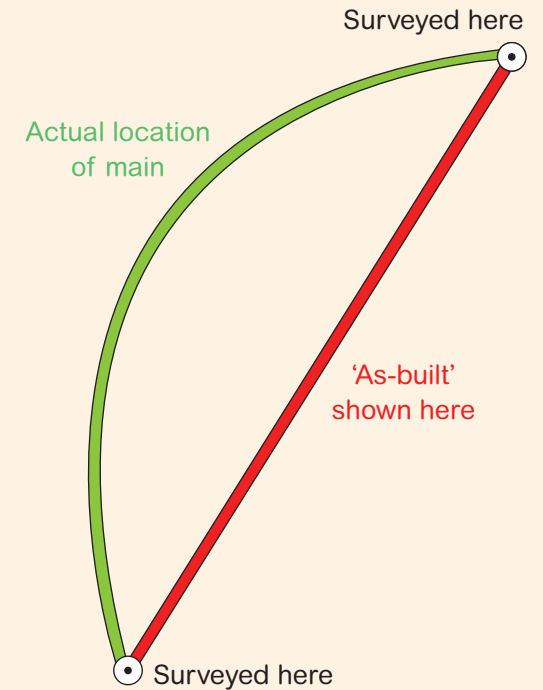

**Always have service plans before you excavate but don't rely on plans alone! Make sure services are marked out.**

ORIGINAL POSITION

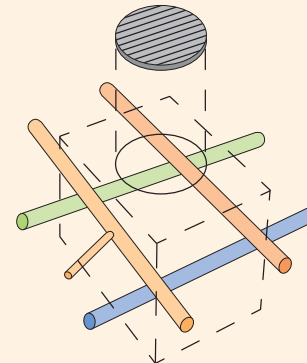

This diagram shows how underground utilities are ideally positioned. Then, due to ground movement or poor 'as-built records' over a period of time, they are often found to have moved substantially.

MOVEMENT OVER TIME

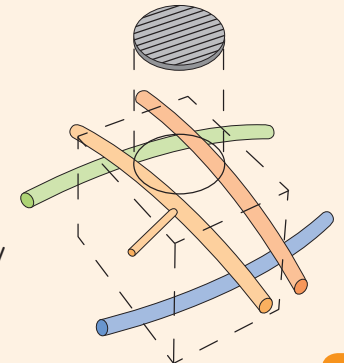

## Expect the unexpected!

Things can change overnight, so check for hazards on your work site every day.

### What could make you slip, trip or fall?

- unsecured climbing equipment
- trip hazards, such as trench edges, tools and machinery
- loose clothing
- falling objects
- working above a trench.

### Are you working in a confined space? Follow best practice guidelines.

Have you checked for:

- any trenches at risk of collapse
- loose objects above the work site, underfoot, or on the sides of the trench
- water or gas hazards from pipes in the ground
- gas fumes, using gas detecting equipment
- rising water table levels
- asbestos
- trench sides are shored up, if required
- buried services including supports for buried services
- risk of optical fibre penetration to eyes or skin
- contaminated materials or contaminated water
- how you will get in or out of a trench
- how others will get you out if a trench collapses.

### What overhead hazards are there?

- overhead lines or trees
- street lights.

### Are you working at heights?

### Are you at risk of electrocution?

Beware of steel pipes, they can carry stray current.

### Are there fumes and hazardous substances around?

- examples are exhaust, carbon dioxide, fuel, solvents, gas etc
- fire and smoke.

### Are there bulk gas or water mains nearby?

- damage to a water main can cause contamination
- be careful when using gas burners near gas pipes.

Look for tags on the roadside.

### What other people are around - and what are they doing?

- public coming on or through the site
- traffic needing to be managed safely - pedestrians and cyclists
- machinery movements on or entering the site
- actions of your co-workers
- poorly maintained equipment
- have you made sure all people are safe?





## Locating utility services

Before you start any digging, you need to know what is in the ground.

### At the very least, you must have:

- current service plans for all utility services located in the ground
- markouts on the ground, or
- staff of the Utility Operator on site as a standover if required.

Check with the Utility Operator for the colours of the ducts and markings of their utility services. You must be sure you know what is in each duct or pipe (see page 31). Markouts can be different for each utility service provider. Sometimes there will be unknown services squatting in ducts and pipes.

- always assume utility services are in the area and treat these as live and shallow. They may not be located where the maps and markouts show
- there may be more services nearby, above or below the utility service you just found
- services may be encased in concrete bases, structures or sleeve pipes
- services can be shallow when crossing obstructions, culverts etc
- cables may not even be in ducts, they may be bundled up
- use spotters to help locate utility services, or
- use cable and pipe locators
- never use machinery inside the marked corridor until all of the utilities have been exposed by hand tools
- **if you find a utility service in a different place from the markout or on the service plan, tell the Utility Operator immediately.**

 **IF YOU DON'T KNOW, ASK!**

## Follow the 'Guide for Safety with Underground Services'.

### Waratah (or "Death Stick"):

If stakes are used for marking out proposed works, **be careful not to drive them straight through any underground services.**

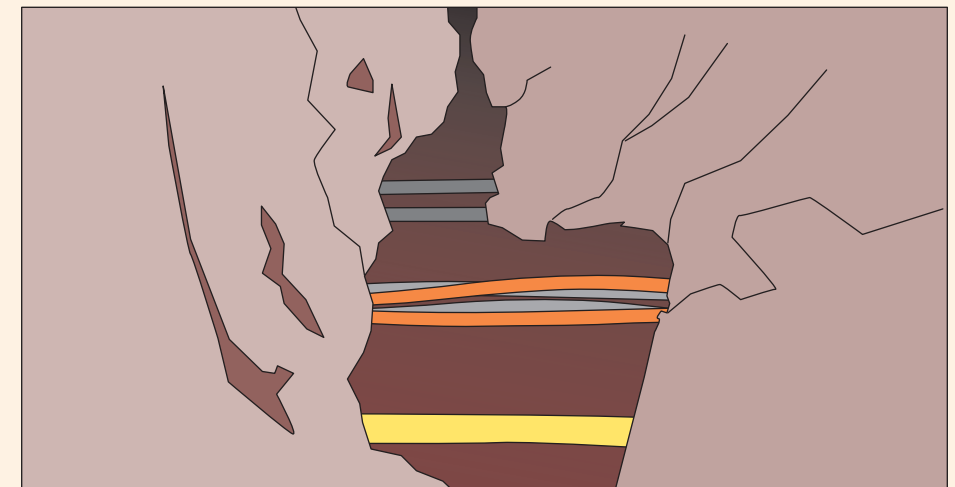
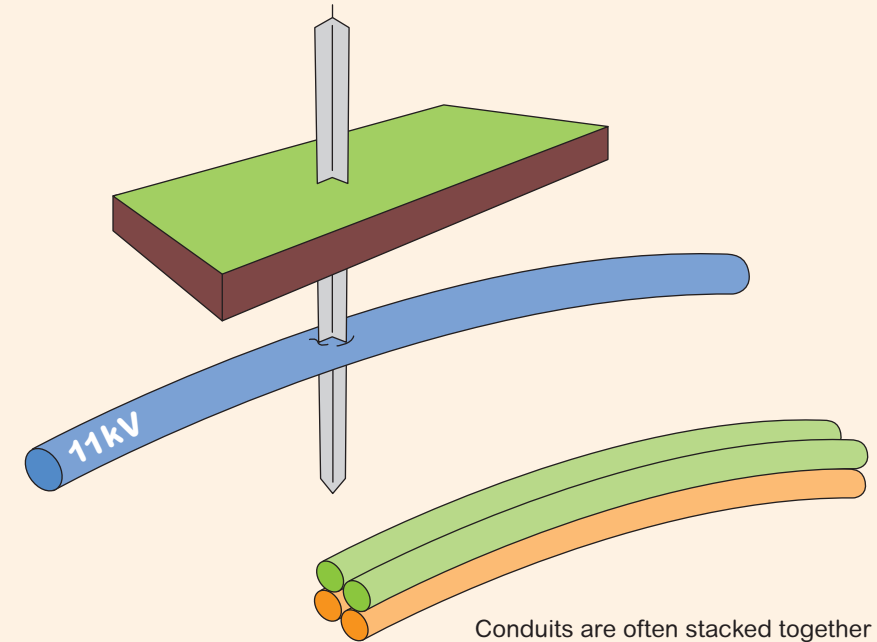

## Follow safe digging practices

These are outlined in the “Guide for Safety with Underground Services”.

### What is digging? It's ANYTHING that disturbs or penetrates the ground:

Pins, shovels, scrapers, excavators, borers, thrusters, hydro/air excavators, directional drillers, ‘Kango’ hammer drills, hand augers, hiab-mounted augers etc, all constitute equipment used in digging.



## You must work safely and carefully around all underground utility services.

Make sure you dig with your shovel **in-line** with the corridor marks at all times. There is less chance of hitting a pipe or cable this way. If possible, use non-conductive tools - they don't take away the need to practise job safety, but they might help minimise personal injury if you hit electricity.

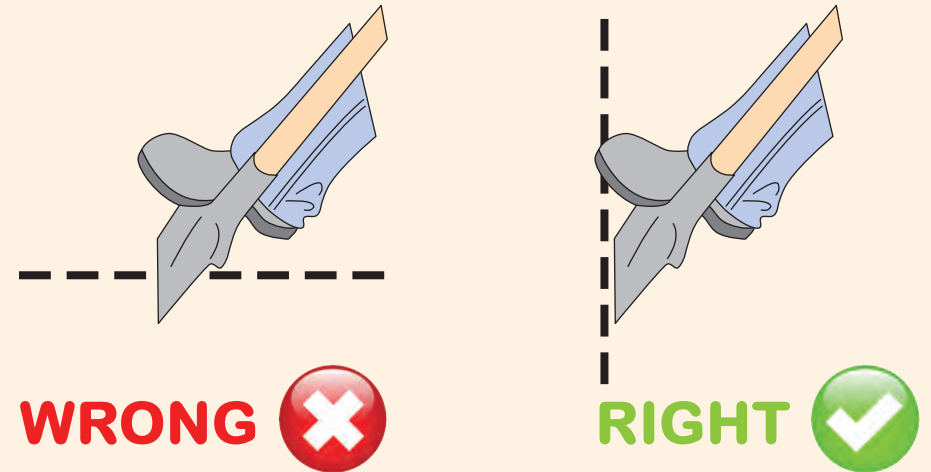

Dig inwards from the edge of the corridor towards the cable. Do not start in the middle of the corridor.

### Standovers

A Utility Operator may want to watch you working, whether digging or backfilling, if you are close to an important pipe or cable. They will wish to ensure that no damage is caused to their utility service, and that you use the correct tools, materials and techniques.

- allow them to observe your work (digging or backfilling) and follow any of their requests
- stop work when the standover requests it, while they check their utility, and help plan the next steps if they feel there is a risk of damage
- ensure you give the required notice to the Utility Operator when working around important pipes and cables, as they may have to isolate the utility service (and this means a shutdown for consumers).

## Working near power lines and cables, trolley bus wires, gas pipelines, high pressure transmission lines, petroleum product transmission lines and bulk water or sewer mains.

These utilities are the most dangerous ones that you will work near.

To ensure your safety, you must follow the rules. Make sure you have plans on site for all underground cables and pipelines. These will show which cables or pipelines are strategic and require a consent.

There are minimum safe distance rules for working near overhead power lines and power poles. Ask your employer for these. These are outlined in **ECP34**, in the NZ Electrical Code of Practice for Electrical Safe Distances.

### The 4 metre rule for electricity

Stay at least 4 metres away from overhead power lines. If you need to get closer, you must obtain a **Close Approach Consent** from the utility owner.

### The 2 metre rule for cables and pipelines

You must hand dig within 2 metres of cables or pipes - do not use any mechanical excavation methods unless you have a standover. **For Gas Transmission pipelines a standover must always be on site.**

### Close approach consents and works agreements

**Electricity:** Consents are required from electricity utility service owners for all works on the ground within 5 metres of a power pole, depending on the depth of the excavation. This ensures that your activity does not cause the pole to collapse. Consents are valid only for the location, type of work, and dates applied for.

There may be specific requirements for backfill for high voltage cables.

### Gas and petroleum pipelines

Consents are required for work within 2 metres of transmission lines or high pressure pipelines. **For Gas Transmission pipelines** a permit is required for **all works** within 10m of a pipeline or pipeline signage. A free standover service is available to assist with gas pipeline identification.

The utility owner may also require a standover while you work.

## Zone restrictions

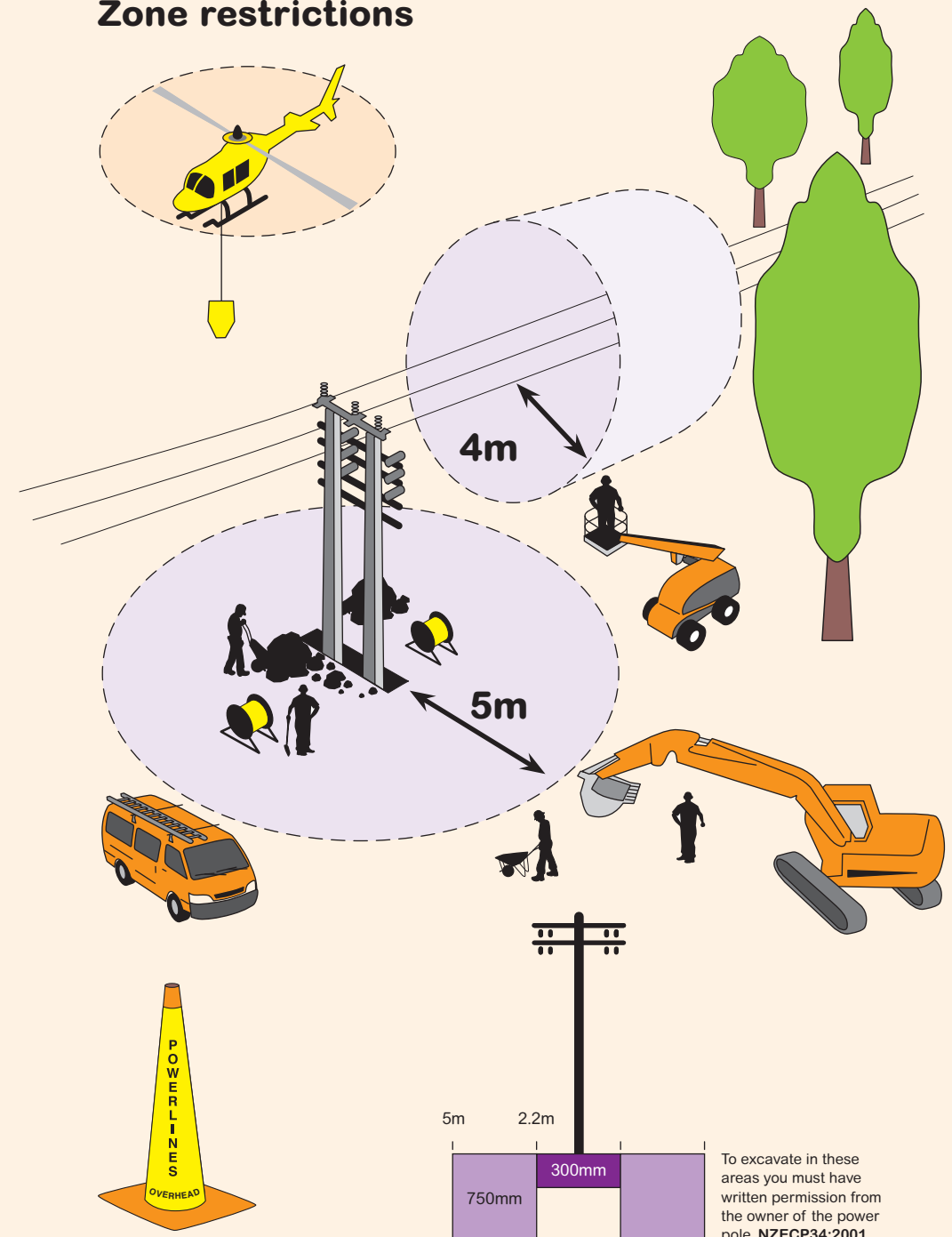

## Traffic management

### You must comply with the Traffic Management Plan (TMP)

Temporary traffic control may be required to ensure traffic safety. It must be:

- as approved or specified by the Corridor Manager
- in place before traffic uses that section of road
- removed before the work area is re-opened to regular traffic.

If there is one, follow the instructions of the **STMS**.

Fire hydrant box lids must be kept visible and accessible at all times during any works.

#### While you are working, you must:

- keep the size of the work site as small as is reasonably possible
- keep the work site tidy at all times
- make sure people can access their own properties near the work site
- manage stormwater and silt, ensuring that there are no unauthorised discharges of contaminants into open water channels
- comply with noise limits and muffle all plant and equipment appropriately
- never use any pipes or cables as steps to get in or out of a trench
- take extra care when working near asbestos pipes to minimise vibration
- keep people out of any trench that requires shoring, until it has been shored
- when digging underneath pipes, cables or joints, provide support to prevent sagging. Seek advice from the Utility Operator.

#### Before you leave the work site each night

- ensure the work site is clean and tidy
- make sure the traffic markings are back in place as per the **TMP**
- make sure your sediment control is in place
- cover any holes
- ensure safety barriers are in place where required
- secure any steel plates
- cover earth mounds
- make sure pedestrian access is safe
- make sure residents have access to their properties
- photograph the work site
- check, check and check again!

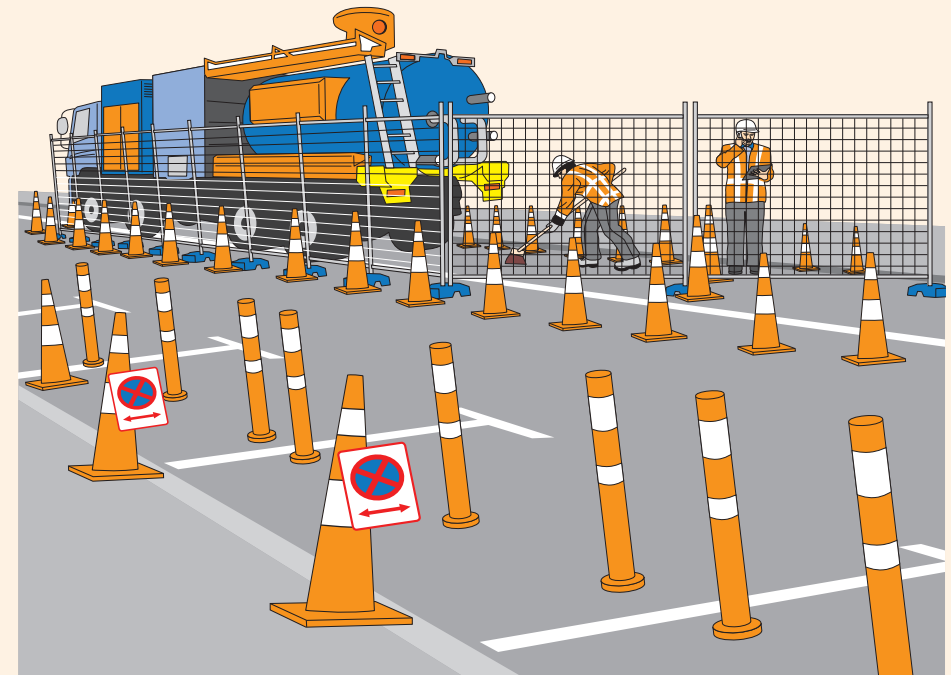

The costs of audits or inspections by Corridor Managers can often end up being charged to the contractor. A good and tidy work site means less cost, fewer stop-work notices, and no non-compliance orders.

## Trees

You must have a tree management plan if you're going to be working within the dripline of trees.

Check whether your local council requires a consent before you can work within the dripline of any tree - and if their arborist wishes to be involved.

### When working near trees, you must:

- watch out for overhead power lines
- know when to hand dig
- use properly qualified people to prune trees and cut tree roots
- use trenchless methods where possible
- protect larger roots, stop them drying out and backfill as soon as possible
- protect the trees from damage from your machinery and equipment.

### You must not store any work-related materials under the dripline of trees

Report any damage to trees to the tree owner.

**If in any doubt, contact a qualified arborist.**

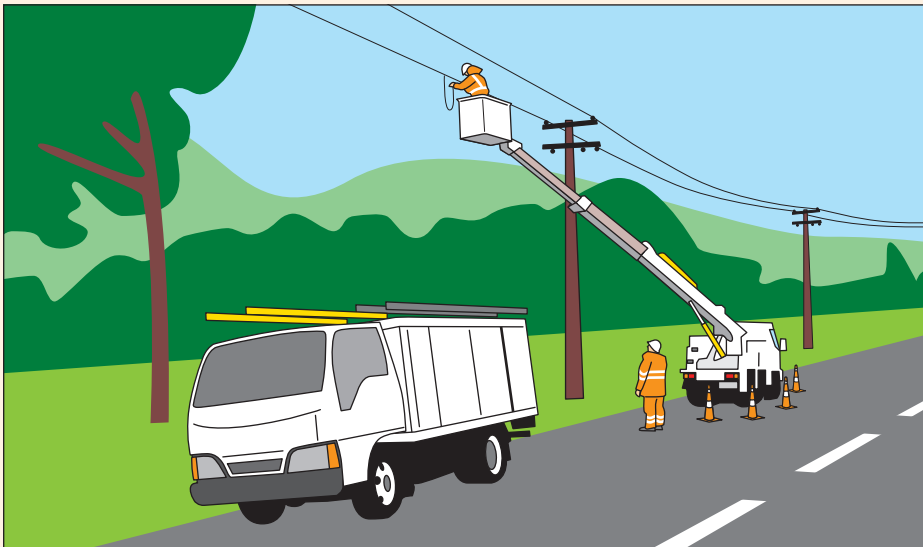

## Tree protection dripline zones

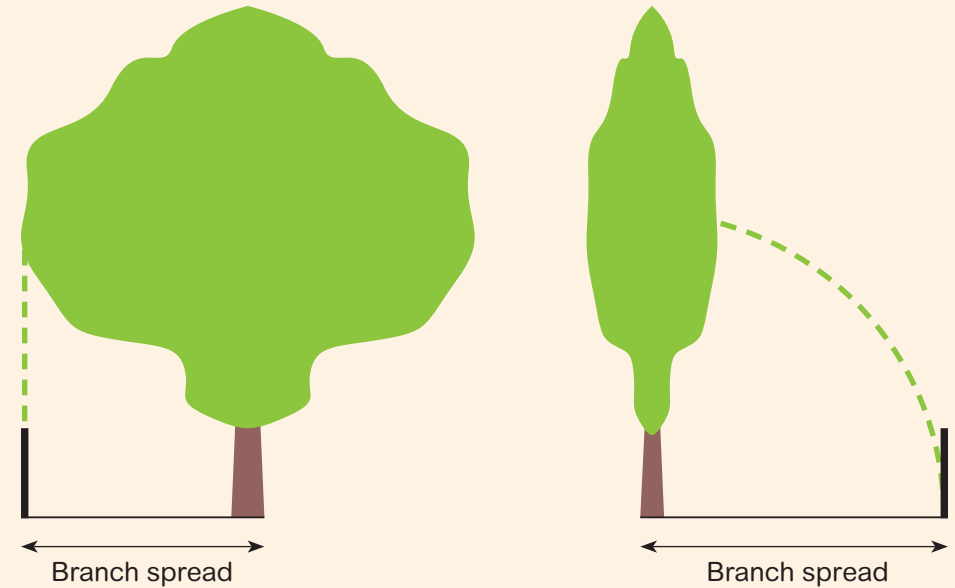

### Spreading canopy trees

The dripline is defined as the outer extent of the branch spread.

### Columnar canopy trees

The dripline is calculated as half the height of the tree.

If in doubt about which to apply, use whichever of the two measurements is the greater.

### Exception

With irregular shaped trees (eg. leaning trees), the dripline is calculated by taking the greatest radial spread of the canopy from the trunk in a full circle around the tree.

## Protection of existing assets

While you do your own tasks in the corridor, you must be careful not to damage anything. If you do hit a utility service, please tell the Utility Operator immediately (rather than try to fix it or conceal it).

A small nick now may lead to the loss of a service later.

### You must not damage:

- underground services, cables, pipes or ducts
- stormwater networks, kerbs, channels, catchpits etc
- the road surface outside your dug area
- roadside furniture (signs, benches, bus shelters, litter bins etc)
- utility structures such as poles and cabinets
- survey marks and pegs
- embankments
- neighbouring properties - drives, fences, plants, letterboxes
- overhead structures including power lines
- trees
- fire hydrants
- tactile pavers or other things set into the road or footpath to help sight or hearing-impaired pedestrians.

Utility services need to be kept separated, while not wasting space in the corridor.

Reinstate all traffic signals, ducts, cables, chambers and poles affected by your works as soon as you can, and by no later than within 48 hours.

This includes repairing or replacing any buried warning tape or wire used to identify utility services there.



If you don't put things back properly as they were, someone may be injured next time, maybe even you or a workmate.

## When you have finished the works:



- you, or the Utility Operator, must send a **Works Completion Notice** to the Corridor Manager
- accurately record the location of the utilities. These include those that you actually worked on, plus any that you discovered were in different places than those shown on the plans provided by the utility owners. Give these records to the Utility Operator.

Reinstate all permanent traffic signs, markings and furniture as they were before you started work.

Be prepared for the Corridor Manager or the Utility Operator to come and carry out an inspection.

If there are any concerns with the quality of the work, particularly the reinstatement of the road surface, you will be required to fix it.

On your last day at the work site, ensure that it is left in the same condition as it was when you arrived to start work on that site. That's where your pre-work photos and videos will prove to be very useful.

 **THINK SAFE,**  
 **WORK SAFE,**  
 **HOME SAFE.**



Remember to have your company's written emergency plans on site at all times and to follow them or...

Follow these instructions below:

## ! WHAT TO DO IN AN EMERGENCY:

If you strike an electricity cable or an overhead line, or if a line comes down:

- treat the cable or overhead line as 'live' and get back at least 10 metres
- isolate the area
- if you are in a machine, stay in your machine
- if you are at **serious risk** from another hazard such as **fire** and **must** leave the machine, jump well clear and **do not touch the machine and the ground at the same time**
- **DO NOT** cover a broken cable or try to fix it yourself
- evacuate the immediate area.

## CALL THE UTILITY OPERATOR IMMEDIATELY.

After any emergency:

- complete an incident report
- discuss what went wrong and how it can be prevented in the future.



# ELECTRICITY STRIKE!



## If you hit a gas pipe, or smell or hear gas escaping:

- switch off all machinery and remove all sources of ignition, including mobile phones
- isolate the work site, including the public and traffic
- move at least **6 metres away UPWIND** (100 metres for a transmission pipeline) and call the **Fire Service** on **111**
- evacuate the immediate area
- leave the damaged pipe to vent
- **DO NOT** try to cover the damaged pipe with any material, including digger buckets
- **DO NOT** start any vehicles for removal
- **DO NOT** attempt to extinguish ignited gas fires
- **DO NOT** inhale fumes.

## CALL THE GAS OWNER IMMEDIATELY.

## If you hit a fibre-optic communications cable:

- **DO NOT** look directly at the cable as laser light will damage your eyesight
- **DO NOT** attempt to repair the cable.

## CALL THE CABLE OWNER IMMEDIATELY.

# GAS LEAK!





## Technical advice for supervisors

Always check the requirements of your local council, as these can vary depending on where you are in the country. And remember to make sure your workers are **always** working safely.

### Maintaining stormwater networks (Code Section:5.1.3)

You need to manage stormwater while you work:

- keep excavations free of water
- install appropriate drainage or flow devices where you are cutting across a slope or underground water flow path (this process needs to be agreed upon with the Corridor Manager)
- retain and protect all existing roadside stormwater systems and collection points
- reinstate any stormwater paths affected by your works
- be careful when you're working in low-lying areas where natural groundwater may be close to the ground surface
- check if any consents are required for the work
- control siltation and any pollution from your works
- silt control devices should be removed if heavy rain is expected.



Stormwater protection on level ground

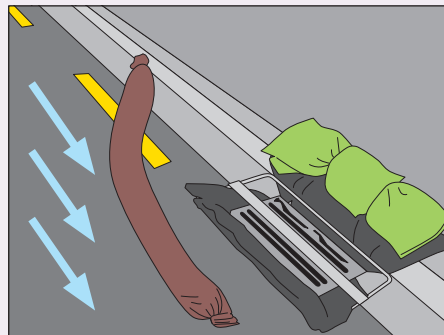

Stormwater protection on incline

## Surface markings and duct colours (CS:3.2.1.3)

You must positively identify which utility exists in any duct or pipe, before you work on, or near to that duct or pipe.

NZ has standard colours which should be used to mark underground utility service ducts and surface markings. As well as ducts, black pipes with coloured stripes at least 5mm wide may be used.

**Always check:** ask the utility owner to confirm the colours of ducts and the identity of their markings.

Some utilities have been laid in plain black pipes and even in wrongly coloured ducts and pipes.

Beware of services or ducts that seem to have been abandoned - there may be unknown services "squatting" inside.

### Colours most commonly used:

SERVICE	DUCT COLOUR	SURFACE MARKING COLOUR	SURFACE MARKING SYMBOLS	COLOURS USED IN THE PAST
Electricity	Orange	Orange	E	Steel, galvanised pipe, asbestos, off-white fibre, off-white concrete, earthenware (ceramic), cast iron, white, grey, brown, multicoloured
Gas	Yellow Black/Yellow Stripe	Yellow	G	Steel, galvanised pipe, cast iron, red, grey, orange
Telecomms	Green Light Blue Purple Salmon	Purple	T CHOR V/COM	Grey, blue, red
Water	Blue, white	Blue	W	Grey, asbestos, galvanised pipe black with red stripe, white, 'any'
Wastewater/ Sewer	Light Grey	Red	SS	Cast iron, orange, red, 'any'
Stormwater	Dark Grey	Pink	SW	Cast iron, green, 'any'

## Trenching procedures (CS:5.5)

There are many risks when working in trenches. You must keep yourself and your workers safe at all times. Remember that you must keep spoil and other materials well back from the top edge of a trench.

- protect public safety at all times
- make sure you have the right approvals from Utility Operators to avoid impacts on their services
- prevent any collapse of kerbing support
- work in accordance with Government guidelines for working with underground services and for trenching
- protect the road surface as much as possible
- have appropriate approvals for trenches over 1.5 metres deep
- keep spoil well back from trench edges so it doesn't spill back in
- shore, bench or batter up the sides of trenches as required by depth and soil conditions and Government codes
- prevent exhaust fumes from building up in trenches.

### When saw cutting, excavating and reinstating, remember:

- follow all legal requirements
- use the correct PPE
- all cutting slurry must be contained, cleaned up, and disposed of properly
- dust nuisance from cutting and excavating must be managed
- keep materials, equipment and vehicles clear of trenches
- stack spoil on the downhill side of a trench, well back from the trench top edge, and cover the spoil to prevent it washing away
- barricade and cover all open and unattended trenches and backfill, or fence them off.

Manage the trench to ensure there is no undercutting or slumping of areas next to the trench.

## Trench cutting and excavation (CS:5.5.2)

- cut, with a power saw, through the full thickness of the surface layer
- saw cut in clean, straight lines, forming a square or rectangle
- make saw cuts before starting excavations
- make sure all edges are straight and smooth.

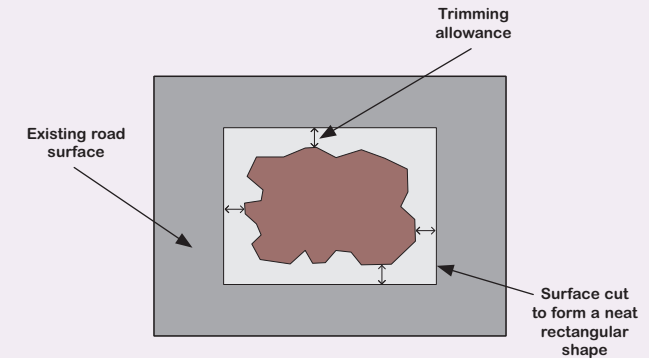

### Overbreaks/overcuts

- make a further cut to maintain trimming allowances and a clean edge for reinstatement
- any change in direction of the saw cut must not be greater than 45°
- do not cut the overbreak more than 10% of the length of the trench
- the trim length for any one over-break must not be less than 1 metre.

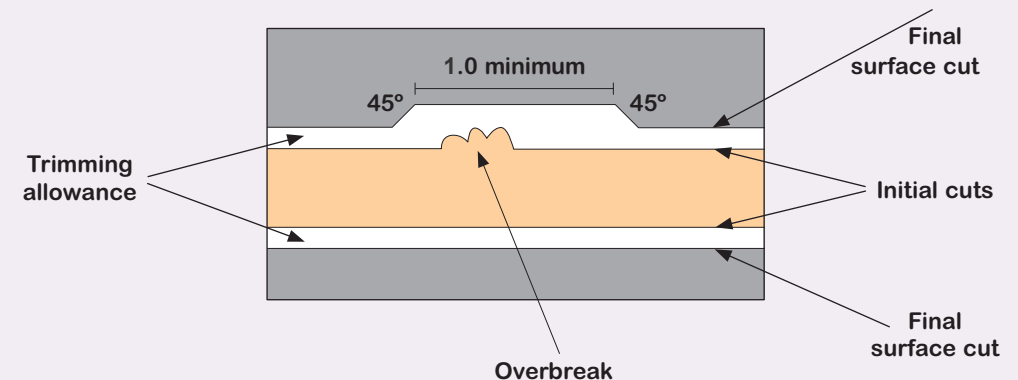

- offset finishing surfaces to prevent water penetration along the line of the trench.

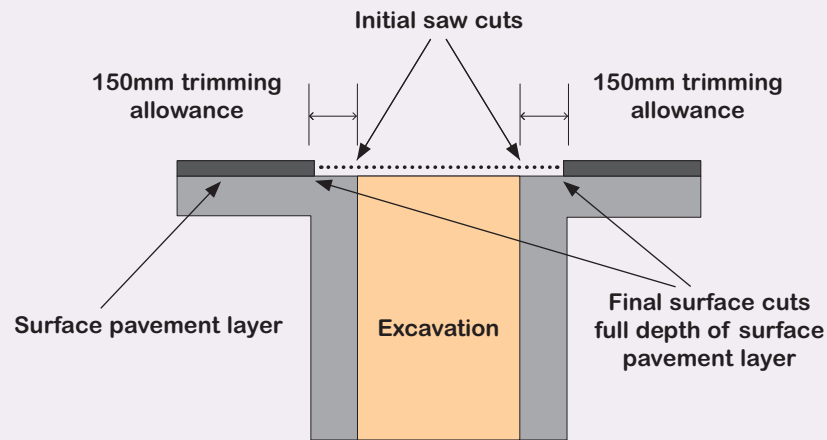

- additional allowances need to be made when trench excavations turn corners.

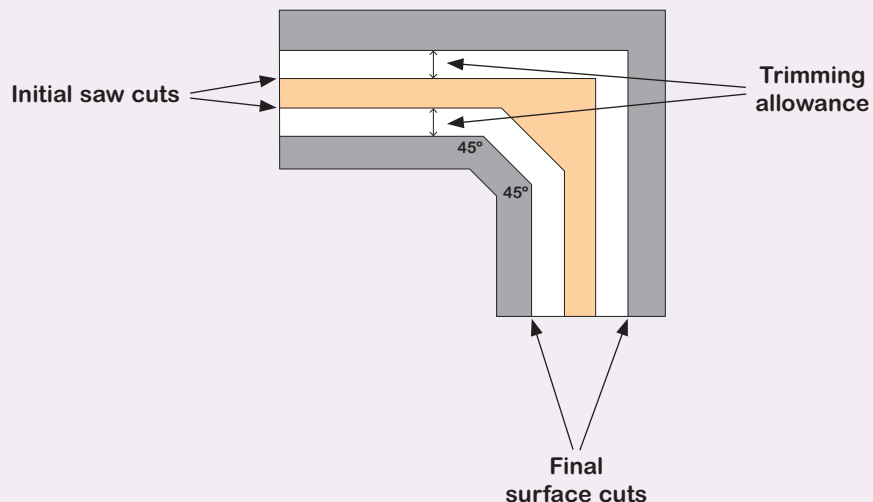

## Backfill materials (CS:5.5.3)

Backfilling a trench correctly is very important to ensure a road or footpath doesn't cave in after you've gone, or utilities are damaged by use of the wrong backfill. Using the correct materials and techniques will save your company time and money.

Backfill materials have to comply with the specifications of the Corridor Manager and utility owners.

All backfill materials must be clean. Most excavated material is not suitable to be placed back in the trench.

### Backfill placement and compaction

When you have finished backfilling a trench, you must ensure it doesn't settle. Generally settlement is caused by inadequate compaction. Unstable ground conditions could also cause slumping of the surrounding area.

#### To avoid settlement:

- compact backfill material
- use appropriate compaction methods around the different utilities
- ensure that no utilities are damaged during compaction
- if any overbreak occurs, re-cut, excavate, and backfill the surface as per page 33
- use the right plant and equipment to achieve the specifications
- ensure backfill is tested using agreed compaction testing equipment.

### Work in compliance with the Code.

- have a **TMP** for each part of the work.



**IF YOU'RE IN DOUBT, ASK!**

## General principles of surface layer reinstatement (CS:5.6)

- trenched sites must not be re-opened to traffic until temporary or permanent surfacing is in place
- if you can't put in permanent resurfacing, use temporary resurfacing **however,**
- permanent resurfacing must be in place within 7 days of completion of backfilling or temporary surfacing or as agreed by the Corridor Manager.

The Corridor Manager may require either a road surface level survey or road roughness testing, before work starts on the site.

Reinstate excavations within 1 metre of an existing joint or edge up to that edge.

**To undertake this work, you must be suitably qualified and experienced.**

**Ensure all work is done in accordance with the Quality Plan for the job.**

## Temporary surface reinstatement (CS:5.6.3)

**Temporary surfaces constructed by the Utility Operator must be:**

- a 'cold mix' asphalt or equivalent, approved by the Corridor Manager
- cold pour on carriageways
- between 5mm below and 15mm above the original surface level, with a lip not greater than 5mm in any part of the surface
- laid in a manner and to a depth that is durable for both vehicular and pedestrian use
- maintained until permanent surfacing has been undertaken, including undertaking any repairs as soon as possible if damaged
- fully removed prior to reinstatement with permanent materials.

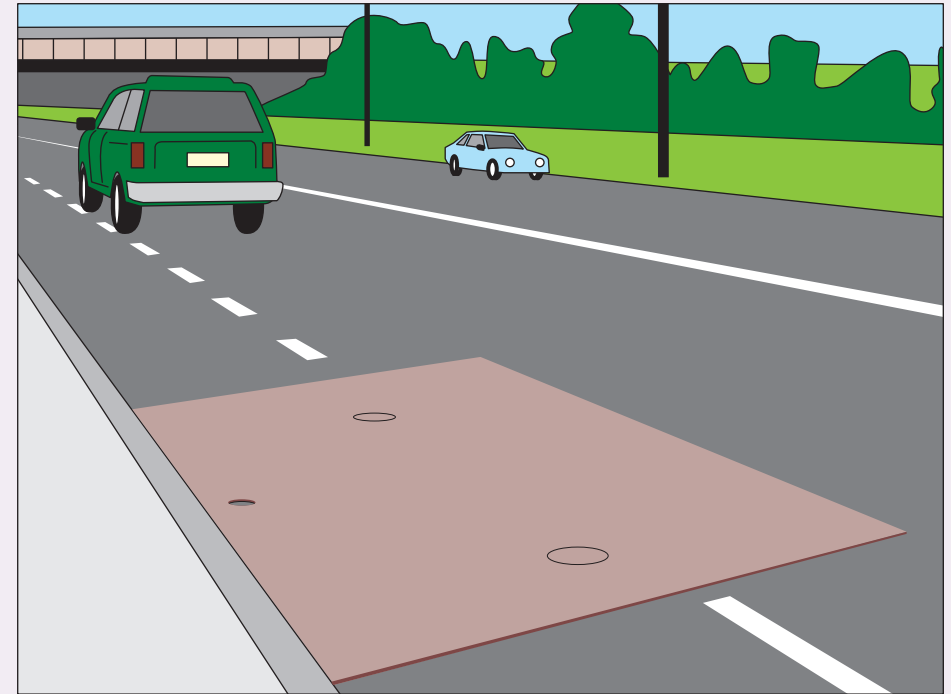

## Steel plates

If steel plates are used, they must:

- be used as approved by the Corridor Manager
- be used in the most appropriate location
- be securely fixed in place to prevent dislodgement and to not be a nuisance or danger to passing traffic, whether vehicles, pedestrians, cyclists or users of local properties
- be skid-resistant, secured and cushioned
- be strong enough to support traffic loads
- have signposts with temporary speed restrictions and hazard warnings
- have a ramp formed to make an easy ride-over
- have any temporary markings required by the Corridor Manager.





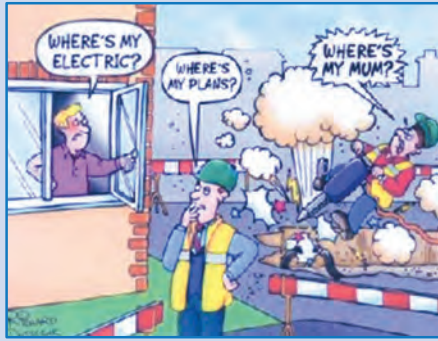

## DIG WITHOUT PLANS? DIG YOUR OWN GRAVE!

The New Zealand Utilities Advisory Group wishes to thank the following organisations who have kindly given their sponsorship for this handbook:

**Auckland Transport**  
**beforeUdig (supplied by PelicanCorp NZ Limited)**  
**Chorus**  
**Christchurch City Council**  
**NZ Contractors Federation**  
**NZ Transport Agency**  
**PowerCo**  
**Watercare**

The following organisations have contributed to the content of this handbook:

Blackley Construction Ltd  
 Capacity Infrastructure Services Ltd  
 Christchurch City Council  
 Chorus  
 Construction Contractors Ltd  
 Downer  
 Electricity Engineers Association  
 Enable Services Ltd  
 Fulton Hogan  
 Gassmart  
 Gold Coast City Council  
 Hastings District Council  
 Leighton NZ Ltd  
 Nova Energy

NZ Contractors Federation  
 NZ Transport Agency  
 Porirua City Council  
 PowerCo  
 Roading NZ  
 SCIRT  
 Tauranga City Council  
 Vector  
 Vision Stream  
 Watercare  
 Wellington City Council  
 WEL Networks  
 Western Bay of Plenty District Council  
 Whangarei District Council

### Principal Sponsors



**New Zealand Utilities Advisory Group Inc.**

Designed and Illustrated by John McDonald - studio@doublefish.co.nz